

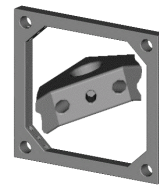

# AFILTRATION.COM, INC.

Manufacturing Plastics Mold Specialist Filter Elements Division.  
 2001 Zapata Street \* Freeport, Texas 77541-3321  
 TEL: (979) 239-1700 \* FAX: (979) 239-1727  
 www.afiltration.com \* E-mail: sales@afiltration.com



## Flush Plate & Frame Filter Element

FPRFPF1200-D

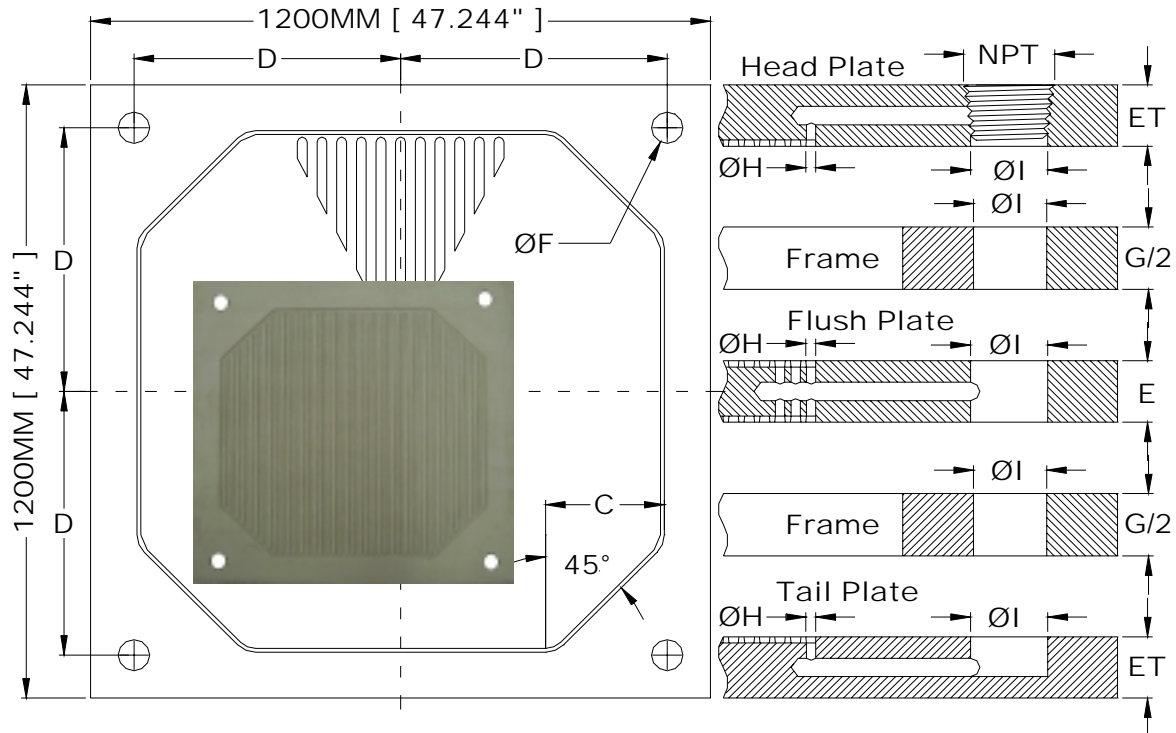

Polypropylene machine to Flush Plate & Frame filter element with ribs filtration area, Ribs height 4 mm, Approx. 70 % open filtration area, Operating pressure 16 bar, Various materials: please see type key Main Dimensions acc.

Aluminum 6061-T6 machine to Flush Plate & Frame filter element with ribs filtration area, Ribs height 4 mm, Approx. 70 % open filtration area, Operating pressure 16 bar, Various materials: please see type key Main Dimensions acc.

Stainless Steel 304 machine to Flush Plate & Frame filter element with ribs filtration area, Ribs height 4 mm, Approx. 70 % open filtration area, Operating pressure 16 bar, Various materials: please see type key Main Dimensions acc.

V= Volume Area (Cu.Ft)

M= Plate Weight

A= Filtration Area (SQ.Ft)

### Dimensions MM

Filter Cake	Support Bossed	Corner Pad	Discharge Holes	Thickness Plate End Plt		Feed Hole	Head Plate	Down Porting	Discharge Dia	Plate Weight	Filter Area	Volume Area
G/2	B	C	D	E	ET	F	NPT	H	I	M	A	V
mm	mm	mm	mm	mm	mm	mm	In	mm	mm	Kg	Ft <sup>2</sup>	Ft <sup>3</sup>
25		200.0	533.40	25	25	76.2	3.00	8.00	76.20	36.3	24.133	0.979
32		200.0	533.40	25	25	76.2	3.00	8.00	76.20	36.3	24.133	1.223
38		200.0	533.40	25	25	76.2	3.00	8.00	76.20	36.3	24.133	1.468
50		200.0	533.40	25	25	76.2	3.00	8.00	76.20	36.3	24.133	1.958

### Dimensions Inch

Filter Cake	Support Bossed	Corner Pad	Discharge Holes	Thickness Plate End Plt		Feed Hole	Head Plate	Down Porting	Discharge Dia	Plate Weight	Filter Area	Volume Area
G/2	B	C	D	E	ET	F	NPT	H	I	M	A	V
Inch	Inch	Inch	Inch	Inch	Inch	Inch	Inch	Inch	Inch	lbs	Ft <sup>2</sup>	Ft <sup>3</sup>
1"		7.874	21.000	1.000	1.000	3.000	3.00	0.315	3.000	80.0	24.133	0.979
1 1/4"		7.874	21.000	1.000	1.000	3.000	3.00	0.315	3.000	80.0	24.133	1.223
1 1/2"		7.874	21.000	1.000	1.000	3.000	3.00	0.315	3.000	80.0	24.133	1.468
2"		7.874	21.000	1.000	1.000	3.000	3.00	0.315	3.000	80.0	24.133	1.958